

I Verglasung / Glazing

| Glasdicke glass thickness | Glasleiste glazing profile | Dichtung sealing profile |
|------------------------------|-------------------------------|-----------------------------|
| 5-40 mm | | |
| 5 | 5-60-40-x | 25-0-1088-x |
| 6 | 5-60-40-x | 25-0-1088-x |
| 8 | 5-60-40-x | 25-0-1086-x |
| 9 | 5-60-40-x | 25-0-1086-x |
| 10 | 5-60-40-x | 25-0-1089-x |
| 12 | 5-35-17-x | 25-0-1088-x |
| 13 | 5-35-17-x | 25-0-1088-x |
| 24 | 5-60-43-x | 25-0-1088-x |
| 25 | 5-60-43-x | 25-0-1086-x |
| 26 | 5-60-43-x | 25-0-1086-x |
| 27 | 5-60-43-x | 25-0-1086-x |
| 28 | 5-60-43-x | 25-0-1089-x |
| 29 | 5-35-08-x | 25-0-1086-x |
| 30 | 5-35-08-x | 25-0-1086-x |
| 31 | 5-35-16-x | 25-0-1088-x |
| 32 | 5-35-16-x | 25-0-1087-x |
| 33 | 5-35-16-x | 25-0-1086-x |
| 34 | 5-35-16-x | 25-0-1086-x |
| 35 | 5-35-16-x | 25-0-1089-x |
| 36 | 5-35-09-x | 25-0-1088-x |
| 37 | 5-35-09-x | 25-0-1088-x |
| 38 | 5-35-09-x | 25-0-1088-x |
| 39 | 5-35-09-x | 25-0-1087-x |
| 40 | 5-35-09-x | 25-0-1086-x |

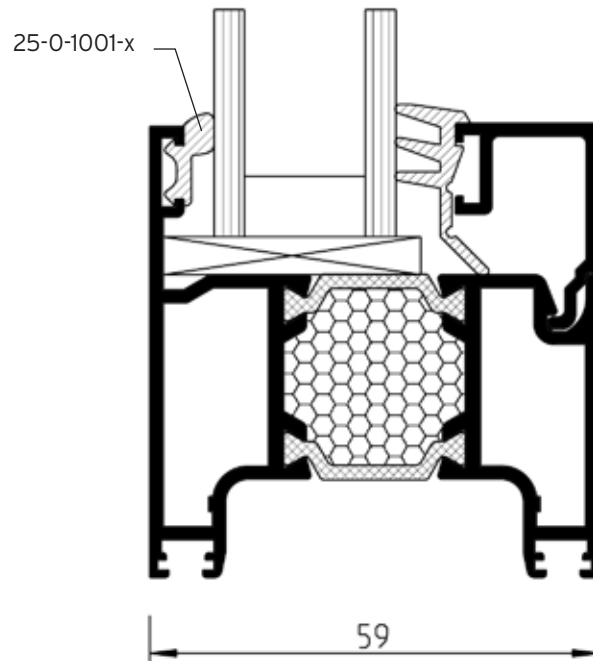

I Glasleisten und Glasdichtungen / Glazing Profiles

25-0-1089-x
 Glasdichtung mit Lippe
 glass gasket with lip



Einbau: 3-4,5mm
 seal gap 3-4,5mm

25-0-1086-x
 Glasdichtung mit Lippe
 glass gasket with lip

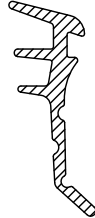

Einbau: 4-6,5mm
 seal gap 4-6,5mm

25-0-1087-x
 Glasdichtung mit Lippe
 glass gasket with lip

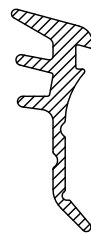

Einbau: 6-7,5mm
 seal gap 6-7,5mm

25-0-1088-x
 Glasdichtung mit Lippe
 glass gasket with lip

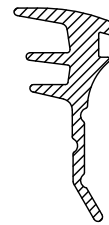

Einbau: 7-9,5mm
 seal gap 7-9,5mm

5-35-08-x
 Glasleistenprofil 16 mm
 glazing profile 16mm

$A_{red} = 122 \text{ mm}$
 $A_{mech} = 36 \text{ mm}$

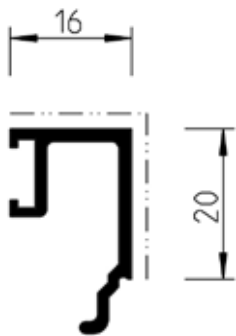

5-35-09-x
 Glasleistenprofil 5mm
 glazing profile 5mm

$A_{red} = 81 \text{ mm}$
 $A_{mech} = 25 \text{ mm}$



5-35-16-x
 Glasleistenprofil 12mm
 glazing profile 12mm

$A_{red} = 114 \text{ mm}$
 $A_{mech} = 32 \text{ mm}$



5-35-17-x
 Glasleistenprofil 30 mm
 glazing profile 30 mm

$A_{red} = 159 \text{ mm}$
 $A_{mech} = 50 \text{ mm}$

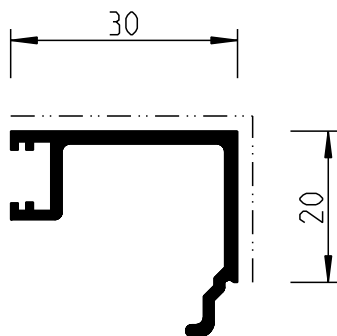

5-60-43-x
 Glasleistenprofil 19 mm
 glazing profile 19 mm

$A_{red} = 128 \text{ mm}$
 $A_{mech} = 39 \text{ mm}$

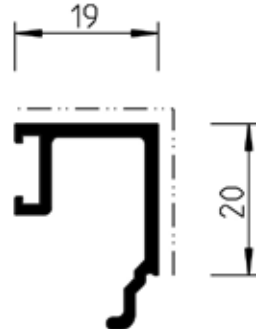

5-60-40-x
 Glasleistenprofil 37 mm
 glazing profile 37 mm

$A_{red} = 165 \text{ mm}$
 $A_{mech} = 57 \text{ mm}$

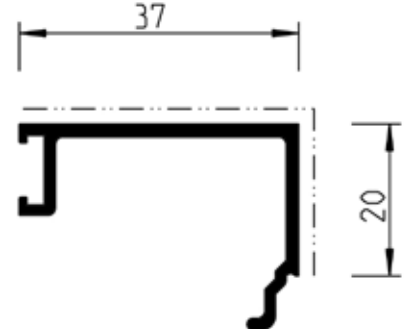

| | |
|--|---|
| A_{red} = Abwicklung reduziert (Fläche Aluminium außen) in mm | ----- = Fläche mit hoher Anforderung bzw. Fläche mech. Bearbeitung |
| A_{mech} = Abwicklung mechanisch (primäre Sichtseite) in mm | - - - - - = Fläche mit üblicher Anforderung (sekundäre Sichtfläche) |
| | ohne Kennzeichnung = Fläche mit geringer oder keiner Anforderung |